

Rugby 100



User Manual

Version 1.5

English

- when it has to be **right**

Leica
Geosystems



This manual contains important Safety Directions (refer to chapter Safety directions) as well as instructions for setting up the product and operating it.

Read carefully through the User Manual before you switch on the instrument.

The symbols used in the User Manual have the following meaning:



DANGER:

Indicates an imminently hazardous situation which, if not avoided, will result in death or serious injury.



WARNING:

Indicates a potentially hazardous situation or an unintended use which, if not avoided, could result in death or serious injury.



CAUTION:

Indicates a potentially hazardous situation or an unintended use which, if not avoided, may result in minor or moderate injury and / or appreciable material, financial and environmental damage.



Important paragraphs which must be adhered to in practice as they enable the product to be used in a technically correct and efficient manner.

Product Identification

The instrument model and serial number of your product are indicated on the label on the base of the unit.

Enter the model and serial number in your manual and always refer to this information when you need to contact your agency or authorized service workshop.

Model-Serial Number: 100-_____ Date of purchase: _____

Copyright Notice

Copyright 2007 by Leica Geosystems AG. All rights reserved

Leica Geosystems Proprietary Information

The information/data contained herein is proprietary information of Leica Geosystems AG and is furnished for your controlled use, and shall not be copied or otherwise reproduced, nor in any manner disclosed to any third party, without Leica Geosystems's prior written consent.

Table of Contents

Introduction and general operation	4
The Rugby 100 Operating Instructions	4
Buttons	6
LED Indicators	8
Basic operation	10
Automatic Operation	10
Manual Operation	10
Using Manual Operation with Grade	11
NiMH Battery Pack	12
Technical Data	13
Rugby 100	13
NiMH Battery Pack	13
NiMH Charger/Adapter	13
Warranty	14
Calibration	15
Checking Level Calibration	15
To Enter Calibration Mode	15
Troubleshooting	17
Care and Transport	19
Transport	19
Storage	19
Cleaning and Drying Windows	19
Safety Directions	20
Intended Use of Instruments	20
Permitted uses	20
Adverse uses	20
Limits of Use	20
Responsibilities	21
Hazards of Use	21
Laser classification	24
Labeling	24
Electromagnetic Compatibility (EMC)	25
FCC Statement (applicable in the U.S.)	25

Introduction and general operation

The Rugby 100 Operating Instructions

The Rugby 100 is easy to understand and simple to use. The picture below gives a brief explanation of each of the switch buttons and the LED indicators.

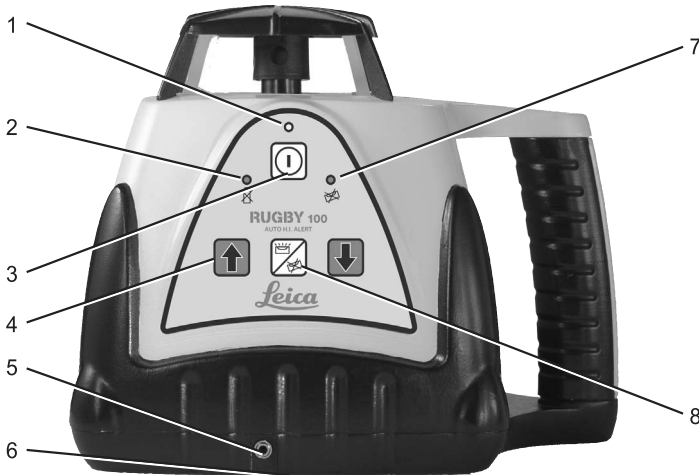

Rugby100-1 Rugby_100_overview.eps

1 **Laser Emission Indicator**

Indicates when the laser is leveling (flashing) or is level and the beam is on (solid).

2 **Low Battery Indicator**

Indicates when the laser's batteries are becoming low.

3 **Off/On Power Button**

Press once to turn the Rugby on at 10 rps. Press again to decrease the head speed to 5 rps. Press a third time to turn the unit off.



Units below Serial Number 100-28500 turn on at 5 rps.

4 **Manual Grade Buttons (2)**

Controls the tilt of the main axis when the Rugby is in Manual mode.

5 **Charge Jack**

For optional NiMH rechargeable battery pack.

6 **Battery Assembly**

Located in the base of the laser. Remove the locking ring to replace the alkaline batteries.

7 **Manual Mode Indicator**

Flashes to indicate manual mode.

H.I. Alert Indication

If an alert condition exists, all three LED indicators will flash simultaneously (5 Hz).

H.I. Alert Automatic

The Rugby 100 will always start up with the H.I. Alert activated. The Rugby must reach a completely level position and remain undisturbed for 30 seconds before the Alert becomes active (above s/n 100-5000).

8 **Automatic/Manual Button**

Press to enter manual mode. Press again to exit and return to automatic self-leveling.



Off/On Power Button

Turns the unit on, off and changes head speeds

- Press the Off/On Power Button once to turn on the Rugby 100 at 10 rps.
- Press the Off/On Power Button a second time to decrease the head speed to 5 rps.
- Press the Off/On Power Button a third time to turn the Rugby 100 off.

When power is applied to the Rugby 100, it will always start up in automatic mode at 10 rps head speed, and with the H.I. Alert function turned on.



Units below Serial Number 100-28500 turn on at 5 rps.



Automatic/Manual Button

Switches the unit between automatic self-leveling mode, and manual mode.

- The Manual Mode Indicator will flash when in this mode.



Manual Grade Buttons (2)

This set of two red buttons controls the tilt of the main axis when the Rugby 100 is in manual mode.



- In manual mode the arrow buttons allow the operator to tilt the head to match an existing line or slope.

- When facing the switch panel and the up arrow is pressed, the plane of laser light will tilt upwards as it moves away from the operator.
- Pressing the arrow buttons will move the head in small increments. Pressing and holding the button move the head more quickly.



Rugby100-2 main_axis.eps

Main Axis Manual Grade

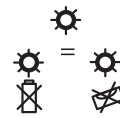

H.I. Alert, also called Height of Instrument or Elevation Alert, when activated will reduce the

amount of self-leveling range to prevent elevation errors as a result of movement of the tripod or other sudden movement.

The H.I. Alert function will automatically turn on when the Rugby 100 is powered up. All three LED's will flash twice to indicate that the Automatic H.I. Function is enabled. Thirty seconds after the Rugby has leveled, the H.I. function will become active. All three LED's will flash once to indicate that the function has been activated.

If the Rugby is disturbed and an alert condition exists, all three LED indicators will flash simultaneously (5 Hz).

- Press the Off/On Power Button to turn off the Rugby and stop the alert.
- Press the Off/On Power Button again to restart the Rugby.
- Check for the cause of the alert, adjust the height of the instrument, allow the unit to relevel.

Disable option - To disable the H.I. Alert function, press and hold both the Up and Down arrows, then press and release the Auto/Manual Button. All three LED's will flash twice to indicate that the H.I. function has been enabled or disabled. The laser must be in automatic to enable/disable the H.I. Alert Function.

(Incorporated on units with serial numbers 100-5000 and above)

LED Indicators

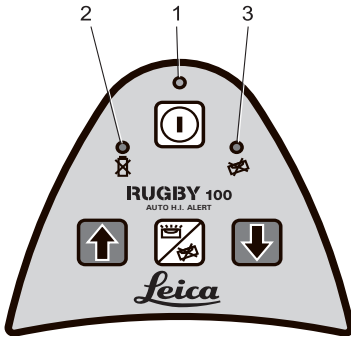

Rugby100-3 Rugby_membrane.eps

1 Laser Emission Indicator (yellow)

- Off: The Rugby and the laser beam are off.
- ☀ Flashing: Leveling in progress.
- On: The Rugby has leveled and the laser beam is on.

2 Low Battery Indicator (red)

- Off: Battery ok
- ☀ Slow Flashing 1Hz: Low Battery
- ☀ Fast Flashing 5Hz: Low Battery, turns off soon
- On: Turns off in 5 Minutes

3 Manual Mode Indicator (red)

- Off: Automatic Self-Leveling
- ☀ Flashing: Manual

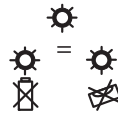

Elevation Alert (H.I.) Indication:

The H.I. Alert function will automatically turn on when the Rugby 100 is powered up. All three LED's will flash twice to indicate that the automatic H.I. Alert function is enabled. Thirty seconds after the Rugby has leveled, the H.I. function will become active. All three LED's will flash once to indicate that the function has been activated. If the Rugby is disturbed and an alert condition exists, all three LED indicators will flash simultaneously (5 Hz). Turn the unit off and on again, check level elevation.

Calibration Mode

- In Calibration Mode, the Low Battery and Manual Mode Indicators will blink alternately.
- In the first axis the Low Battery will blink at 5 Hz, the Manual Mode at 1 Hz.
- In the second axis the Low Battery will blink at 1 Hz, the Manual Mode at 5 Hz.
- When an arrow button is pressed to change calibration, the Emission Indicator LED will turn off for one half second to indicate a button press.

Out of Level Indication

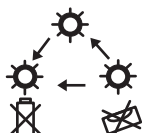

When there is an Out of Level Failure, the Rugby has been set up outside of its self-leveling range and cannot achieve

level. The LED's will blink in sequence. Turn the unit off, level the top of the tripod and try again.

Out of Temperature Range



If the unit is set up and the environment is out of the specified operating temperature range, all three LED's will turn on

at the same time. The operating temperature range for the Rugby is -4° to $+122^{\circ}$ F (-20° to 50° C).

Automatic Operation



- Set up the Rugby 100 on a 5/8"-11 Tripod or flat level surface.
- Press the Off/On Power Button once to turn on the laser at 10 rps.
- Press the Off/On Power Button a second time to decrease to 5 rps.

 Units below Serial Number 100-28500 turn on at 5 rps.

- The Rugby 100 will self-level and then begin to rotate.
- Automatic H.I. Alert will become active after 30 seconds.
- Work can begin.

Manual Operation

- Set up the Rugby 100 on a 5/8"-11 Tripod or flat level surface.
- Press the Off/On Power Button once to turn on the laser at 10 rps or twice at 5 rps.
- Press the Automatic/Manual Button once to operate the Rugby in manual mode.
- Align the plane of laser light to the jobsite requirements.
- Work can begin.

Using Manual Operation with Grade

Setting up the Rugby with manual grade can be accomplished by one person, but it is generally easier using two people working together. The Rugby should be set up so that the operator is looking at the switch panel and the area to be graded beyond the laser.

- Set up the Rugby at one end of the area to be graded, put the Rugby in manual mode, and take a reading using your Rod-Eye receiver directly in front of the laser (more than three feet/one meter from the laser for best results).
- Have a second person move to a control point at the other end of the jobsite and adjust the height. Manually increase (decrease) the grade of the Rugby until a beep is heard on the receiver.
- The second person should hold the grade rod still and indicate to the operator when the beam is too high or too low by observing the audio tones and arrow indications on the Rod-Eye receiver.
- Adjust the manual grade until the center bar and/or solid tone is heard from the receiver.



Rugby100-4 main_axis.eps

Main Axis Manual Grade

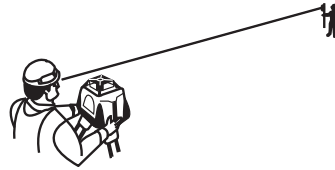

Rugby100-5 setup for mgrade.eps

Setting up the Rugby for Manual Grade

NiMH Battery Pack

General Information

The battery pack contains four high capacity D-cell Nickel Metal Hydride Batteries. Fully charged the Rugby will run more than 35 hours in optimal conditions.

The charger/adaptor is a universal charger and will accept an input voltage from 100 to 240 VAC. The charger requires that the correct cable be ordered for the country of use.

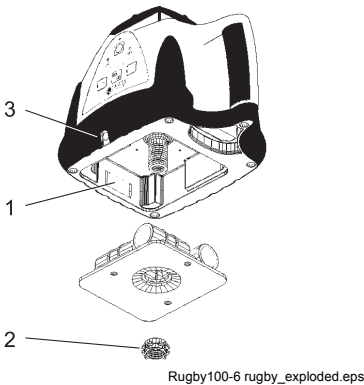

Installation

The NiMH Battery Pack will fit into the bottom of the Rugby in only one direction. The three silver tabs on the battery should be aligned with the tabs (1) in the base of the laser. Lock the battery pack in place using the large plastic nut (2).

Charging

The charge jack (3) is located on the front of the Rugby. Insert the plug into the jack and the AC adapter into the appropriate wall outlet. The NiMH Battery Pack can also be charged separately from the laser.

Low Battery Indication

There is a low battery, warning indicator on the switch panel of the Rugby that will indicate when the batteries require recharging. Should the batteries become low, the charger/adaptor will both run and charge the laser at the same time.

NiMH Battery Pack Care

To ensure optimal performance and life of the NiMH Battery Pack, please note the following guidelines:

 Exposure of batteries to extreme temperatures can cause battery degradation and early failure.

Long-term storage of the battery pack should be in moderate temperatures - 0°F to 95°F (-18°C to 35°C). If the batteries are to be stored for an extended period of time, fully charge them and then remove them from the laser unit. If stored for more than 60 days, it is recommended that the batteries be recharged to extend their useful life. Always charge the batteries in an area of moderate temperatures.

Troubleshooting

If your Rugby laser will not take a charge, check the following:

- Check the AC input and DC output of the charger unit.
- Check that the Rugby has a rechargeable pack installed.
- Check charger cables for wear or damage.
- Refer to your Rugby User Manual for proper operation.
- Contact the nearest authorized service center.

Technical Data

Rugby 100

Operating Range	1000' (300 meters) Diameter
Self-Leveling Accuracy	$\pm 1/16"$ at 100 feet (± 1.5 mm at 30 meters)*
Self-Leveling Range	$\pm 5^\circ$
Manual Grade	Up to 10%
Height	7.8" (197 mm)
Width.....	9.8" (248 mm)
Depth	6.9" (175 mm)
Weight with Batteries	6.5 lbs. (2.95 kg)
Rotation Speeds	5, 10 rps
Laser Diode	635 nm visible
Laser Classification.....	Class II FDA21CFR/Class 2 IEC60825-1
Operating Temperature	-4° to 122°F (-20° to 50°C)
Storage Temperature.....	-40° to 158°F (-40° to 70°C)
Battery Life.....	60 hours with alkaline/ 35 hours with NiMH**
Batteries.....	Four D-Cell Alkaline or NiMH Pack
Environmental.....	Waterproof, IP66

NiMH Battery Pack

Input voltage	7.5 VDC
Input current.....	1.0 amp

NiMH Charger/Adapter

Input voltage	100 to 240 VAC, 50-60 Hz
Output voltage	7.5 VDC
Output current.....	1.0 amps
Polarity.....	Shaft – negative, Tip – positive

* Increased accuracy beginning serial number 100-61500. From 23° to 95°F (-5° to 35°C). Accuracy is derated outside this range.

** Battery life is dependent upon environmental conditions.

Specifications are subject to change without notice.

Warranty

Leica Geosystems warrants the Rugby 100 to be free of defects in materials and workmanship under normal use and service for a period of 24 months, provided that the product has been properly used and cared for as stated in the User Manual. Any evidence of an attempt to repair the Rugby by other than factory authorized personnel using Leica Geosystems certified replacement parts will automatically void the warranty.

Knockdown Warranty - In addition to the standard Leica Geosystems 24 month warranty, the internal self-leveling system of the Rugby 100 is covered regardless of failure. Should any accident or knockdown occur within the warranty period, all repairs to the internal self-leveling assembly will be covered under the knockdown warranty policy.

Leica Geosystems liability under this warranty is limited to repairing or replacing any product returned to a factory authorized service facility for that purpose. The foregoing states the entire liability of Leica Geosystems in connection with the Rugby 100, and they shall not be held responsible for any consequential damage of any kind. The foregoing is in lieu of all other warranties expressed or implied.

The user of the Rugby 100 is expected to follow all operating instructions, periodically checking the instrument and the work as it progresses. Checking and ensuring the calibration of the Rugby 100 is the responsibility of the user. Calibration and maintenance is not covered by the above warranty.

Calibration

 The Rugby is calibrated to the defined accuracy specification at the factory. It is recommended to check your laser for calibration upon receipt and periodically before using the laser to ensure calibration is maintained. Refer to the warranty card for further information. If your laser requires calibration, send it to your nearest authorized service center, or calibrate the laser using the following procedure.

 Do not enter this mode or attempt calibration unless you plan to change the calibration. Calibration should be performed only by a qualified individual that understands basic calibration principles.

Checking Level Calibration:

To check level calibration of your Rugby Laser, place the unit on a flat, level surface or tripod approximately 100 ft (30 m) from a wall.

Align Axis one of the Rugby so that it is square with the wall. Allow the unit to self-level completely approximately one minute after the unit begins to rotate), and then mark the position of the beam (position 1).

Rotate the Rugby 180°, allow it to self-level and mark the opposite side of the first axis (position 2).

Align the second axis of the Rugby by rotating it 90° so that this axis is now square with the wall. Allow the unit to self-level completely, and then mark the position of the beam (position 3).

Rotate the Rugby 180°. allow it to self-level and mark the opposite side of the second axis (position 4).

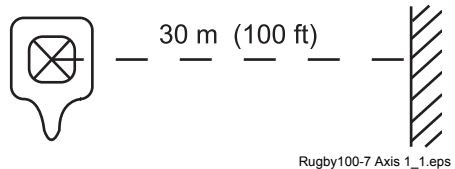

Axis 1 (Position 1)

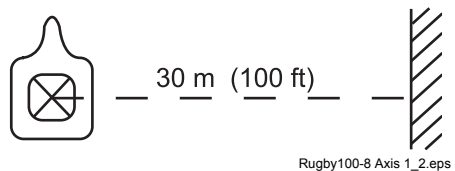

Axis 1 (Position 2)

The Rugby is within its calibration specification if the four marks are within $\pm 3/32"$ (2.6 mm) from center.

 Increased accuracy specified beginning serial number 100-61500 is now $\pm 1/16"$ (± 1.5 mm).

To Enter Calibration Mode:

- 1 With the power off, press the Power Button once to turn on power.
- 2 Press and hold the Up and Down Arrow Buttons. While holding these buttons, press and release the power button. Then, release the arrow buttons.

- The Rugby is now in calibration mode. The low battery indicator will blink at 5 Hz and the out of level indicator will blink at 1 Hz alternately to confirm that the unit is in calibration mode for Axis One.



Rugby100-9 Cal Mode 5 to 1.tif

Do not push the arrow buttons unless you plan to change calibration! To exit this mode, press the power button once. The unit will power off without making any changes.

- Align the unit so that you are facing the control panel and looking over the top of the unit to the calibration marks on the wall. This is Axis One (position 1).

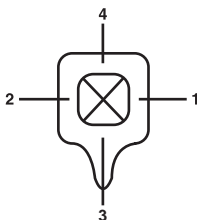

Rugby100-10 Rugby top view1.eps

Axis One (1-2)
Axis Two (3-4)

- Use the Up or Down Arrow Buttons to raise or lower the beam to the desired elevation for level calibration in position 1. When the arrow button is pressed, the top laser emission indicator LED will turn off for one half second to indicate that a key has been pressed.

- Rotate the laser 180° and check the opposite side of Axis One (position 2).
- Reposition the Rugby so that the handle is now pointing at the calibration marks on the wall. This is Axis Two (position 3).
- Press the Auto/Manual Button to enter the calibration mode for the second axis. The low battery and out of level indicators will now reverse their blink modes to confirm the Rugby is now in calibration mode for Axis Two.
- Use the Up or Down Arrow Buttons to raise or lower the beam to the desired elevation for level calibration in Axis Two (position 3). When the arrow button is pressed, the top, laser emission indicator LED will turn off for one half second to indicate that a key has been pressed.
- Rotate the laser 180° and check the opposite side of Axis Two (position 4).
- Once the desired calibration has been set for both axes, press the Power Button once to store the information and turn the power off. The Rugby will be set to the new calibration when power is re-applied.

Troubleshooting

Symptom	Possible Causes and Solutions
The Rugby 100 does not turn on.	<p>The battery charge is low or dead.</p> <ul style="list-style-type: none"> • If the Rugby 100 has alkaline batteries, remove the battery pack from the base of the Rugby and replace all four batteries with fresh D-cell alkaline batteries. • If the Rugby 100 has a rechargeable (NiMH) battery pack, plug the battery charger into the Rugby's charge jack and then connect it to a standard electrical outlet. Always plug the battery charger into the Rugby's charge jack first and then plug it into the electrical outlet, otherwise the Rugby's charge jack might emit sparks.
The Rugby 100 does not turn off.	<p>The Off/On Power Button is used also to change the speed of the rotating head.</p> <ul style="list-style-type: none"> • Press once to turn the Rugby on at 5 rps. Press a second time to increase the speed of the rotating head to 10 rps. Press a third time to turn the unit off.
The Rugby 100 is working, but it does not self-level.	<p>The Rugby 100 must be in automatic mode to self-level.</p> <ul style="list-style-type: none"> • In automatic the emission indicator will blink until the laser has completed self-leveling. • In manual mode the Manual Mode Indicator will flash slowly at 1 Hz and the Rugby will not self-level.
The Rugby 100 has stopped working and all three LED's are flashing.	<p>The Rugby 100 is displaying an elevation alert.</p> <ul style="list-style-type: none"> • Press the Off/On Button to stop the alert. Press again to turn on the laser. Check and adjust the elevation of the laser. The H.I. Alert function will become active after the laser has leveled and is undisturbed for 30 seconds.

Symptom	Possible Causes and Solutions
The Laser Emission, Low Battery and Manual Mode Indicators are flashing sequentially. (Out of Level Indication)	<p>The Rugby 100 has reached a servo limit or is outside of its self-leveling range.</p> <ul style="list-style-type: none"> • In automatic mode the Rugby 100 must be set up within $\pm 5^\circ$ of its upright position to be within the self-leveling range. • Reposition the Rugby. If the LED's continue to flash, turn off the Rugby and try again.
The Laser Emission, Low Battery and Manual Mode Indicators are all on. (Out of Temperature Range)	<p>The internal temperature has exceeded its operating temperature range of -4° to 122°F (-20° to 50°C).</p> <ul style="list-style-type: none"> • Move the laser out of direct sunlight or shield it. • Allow the Rugby to cool and it will automatically begin operation.
The Low Battery Warning Indicator is on.	<p>The battery charge is low or dead.</p> <ul style="list-style-type: none"> • See symptom #1 above. • See explanation of LED indicator functions.
The Rugby's distance is reduced.	<p>Dirt is reducing the output of the laser.</p> <ul style="list-style-type: none"> • Clean the windows on the Rugby and the Rod-Eye receiver to improve performance.
The Rod-Eye receiver is not functioning properly. (See also the Rod-Eye User Manual.)	<p>Check for proper operation.</p> <ul style="list-style-type: none"> • The Rugby is not rotating. It is leveling or in elevation alert. • The power or audio feature is not active on the Rod-Eye. • The Rod-Eye is out of usable range. • The Rod-Eye's batteries are dead or low.

Transport

 When dispatching the instrument, always use the complete original Leica Geosystems packaging (case and cardboard box).

When transporting the instrument in the field, always make sure that you:

- Either carry the instrument in its original transport case
- Or carry the tripod with its legs splayed across your shoulder, keeping the attached instrument upright.

Never carry the instrument loose in a road vehicle. It can be affected by shock and vibration. Always carry it in its case and secure it.

When transporting the instrument by rail, air or ship, always use the complete original packaging (case and cardboard box), or its equivalent, to protect it against shock and vibration.

 After transport, or after long periods of storage, inspect the field adjustment parameters given in this user manual before using the instrument.

Storage

 Temperature Limits (-40° to 70°C / -40° to 158°F) Respect the temperature limits when storing the instrument, particularly in summer if the instrument is inside the vehicle.

 Damp instruments must be unpacked. Dry the instrument, the case and the accessories at not more than 40°C / 108°F and clean them. Do not repack until everything is completely dry.

Cleaning and Drying Windows

 Windows

- Never touch the glass with your fingers.
- Use only a clean, soft, lint-free cloth for cleaning. If necessary, moisten the cloth with pure alcohol. Use no other liquids; these may attack the polymer components.

Safety Directions

The following directions should enable the person responsible for the laser unit, and the person who actually uses the instrument, to anticipate and avoid operational hazards. The person responsible for the instrument must ensure that all users understand these directions and adhere to them.

Intended Use of Instruments

Permitted uses

The Rugby 100 is designed and suitable for the following applications, within the limits of its intended conditions of use:

- The instrument casts a horizontal laser plane or a laser beam for the purposes of alignment.
- The unit can be set up on its own baseplate or on a tripod.
- The laser beam can be detected by the object being surveyed or by means of a laser detector.
- The laser unit, combined with machine control receivers, is also suitable for guiding construction machinery.
- The unit can be powered by rechargeable NiMH (optional) or Alkaline batteries.

Adverse uses

- Use of the product without instruction.
- Use outside of the intended limits.

- Disabling safety systems and removal of hazard notices.
- Opening the instrument using tools (screwdriver, etc.).
- Modification or conversion of the instrument.
- Use after misappropriation.
- Use with accessories from other manufacturers without the prior express approval of Leica Geosystems.
- Inadequate safeguards at the measuring station (e.g. when measuring on roads).
- Deliberate dazzling of third parties.



WARNING:

Adverse use can lead to injury, malfunction, and material damage. It is the task of the person responsible for the instrument to inform the user about hazards and how to counteract them. The laser unit is not to be used until the user has been instructed how to work with it.

Limits of Use

Environment:

Suitable for use in an atmosphere appropriate for permanent human habitation. Cannot be used in an aggressive or explosive environment. See *chapter "Technical Data"*.

Responsibilities

Responsibility for the manufacturer of the original equipment Leica Geosystems AG, Heerbrugg (hereinafter referred to as Leica Geosystems):

Leica Geosystems is responsible for supplying the product, including the user manual and original accessories, in a completely-safe condition.

Responsibilities of the manufacturers of non-Leica Geosystems accessories:

 The manufacturers of non-Leica Geosystems accessories for the laser unit are responsible for developing, implementing and communicating safety concepts for their products, and are also responsible for the effectiveness of those safety concepts in combination with the Leica Geosystems product.

Responsibilities of the person in charge of the instrument:

 **WARNING:** The person responsible for the instrument must ensure that it is used in accordance with the instructions. This person is also accountable for the training and the deployment of personnel who use the instrument and for the safety of the equipment in use.

The person in charge of the instrument has the following duties:

- To understand the safety instructions on the product and the instructions in the user manual;
- To be familiar with local regulations relating to accident prevention;

- To inform Leica Geosystems immediately if the equipment becomes unsafe.

Hazards of Use

Main hazards of use

 **WARNING:** The absence of instruction, or the inadequate imparting of instruction, can lead to incorrect or adverse use, and can give rise to accidents with far-reaching human, material, financial, and environmental consequences.

Precautions: All users must follow the safety directions given by the manufacturer and the directions of the person responsible for the instrument.

 **WARNING:** The charger is not designed for use under wet conditions. If the unit becomes wet it may cause you to receive an electric shock.

Precautions: Use charger only indoors, in dry rooms and protect it from dampness. If the charger is damp, do not use it.

 **WARNING:** The charger contains potentially hazardous voltages. Opening the charger, may cause you to receive an electric shock.

Precautions: Do not open the charger.

**CAUTION:**

Watch out for erroneous measurements if the product is defective or if it has been dropped or has been misused or modified.

Precautions: Periodically carry out test measurements and perform the field adjustments indicated in the user manual, particularly after the instrument has been subjected to abnormal use and before and after important measurements.

**WARNING:**

By working during a thunderstorm you are at risk from lightning.

Precautions: Do not carry out field work during thunderstorms.

**DANGER:**

Because of the risk of electrocution, it is very dangerous to use staffs and telescopic scales in the vicinity of electrical installations such as power cables or electrical railways.

Precautions: Keep at a safe distance from electrical installations. If it is essential to work in this environment, first contact the safety authorities responsible for the electrical installations and follow their instructions.

**WARNING:**

Inadequate securing of the working site can lead to dangerous situations, for example in traffic, on building sites, and at industrial installations.

Precautions: Always ensure that the working site is adequately secured. Adhere to the regulations governing accident prevention and road traffic.

**CAUTION:**

During the transport or disposal of charged batteries it is possible for inappropriate mechanical influences to constitute a fire hazard.

Precautions: Remove the batteries from their compartment before they are transported. Disposal of batteries only if they are fully flat.

**CAUTION:**

If the accessories used with the instrument are not properly secured and the equipment is subjected to mechanical shock (e.g. blows, falling), the equipment may be damaged or people may sustain injury.

Precautions: When setting-up the instrument, make sure that the accessories (e.g. tripod, tribrach) are correctly adapted, fitted, secured, and locked in position. Avoid subjecting the equipment to mechanical shock. Never position the instrument on the tripod baseplate without securely tightening the central fixing screw. If the screw is loosened, always remove the instrument immediately from the tripod.

**WARNING:**

If the product is improperly disposed of, the following can happen:

- If polymer parts are burnt, poisonous gases are produced which may impair health.
- If batteries are damaged or are heated strongly, they can explode and cause poisoning, burning, corrosion or environmental contamination.
- By disposing of the product irresponsibly you may enable unauthorized persons to use it in contravention of the regulations, exposing them-selves and third parties to the risk of severe injury and rendering the environment liable to contamination.
- Improper disposal of silicone oil may cause environmental contamination..

Precautions:

The product must not be disposed with household waste.

Dispose of the product appropriately in accordance with the national regulations in force in your country.

Always prevent access to the product by unauthorized personnel.

Product specific treatment and waste management information can be downloaded from the Leica Geosystems home page at <http://www.leica-geosystems.com/treatment> or received from your Leica Geosystems dealer.

**WARNING:**

Use only the approved charger designed for this battery pack. See manufacturer's reference below.

Precautions: Reference GlobTek Part Nr: TR9KC1000PTP-N, Model: GT-4121DA-09-1.5

Laser classification



CAUTION:

Only Leica Geosystems authorized workshops are entitled to repair these products.

The rotating laser Rugby 100 produces a visible red laser beam which emerges from the rotating head.

The product is a Class 2 laser product in accordance with:

- IEC 60825-1:2001 "Radiation safety of laser products"
- EN 60825-1:1994 + A11:1996 "Radiation safety of laser products"

The product is a Class II laser product in accordance with:

- FDA 21CFR Ch.I §1040: 2002 (US Department of Health and Human Service, Code of Federal Regulations)

Class 2/II laser products: Do not stare into the beam or direct it unnecessarily at other persons. Eye protection is normally afforded by aversion responses including the blink reflex.



WARNING:

It can be dangerous to look into the beam with optical equipment (i.e. binoculars, telescopes)

Precautions: Do not look directly into the beam with optical equipment.

Beam divergence:..... 0.2 mrad
 Maximum radiant power:..... 3 mW rotating mode
 Measurement uncertainty: ±5%
 Pulse duration.....Not applicable
 Max. radiant power per pulseNot applicable

Labeling

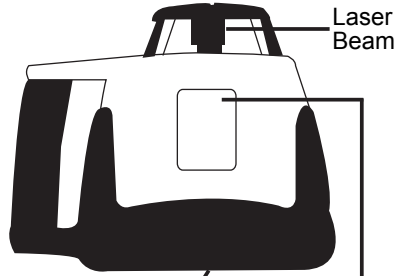

Laser Beam

AVOID EXPOSURE

Laser radiation is emitted from this aperture

This device complies with part 15 of the FCC Rules. Operation is subject to the following two conditions:
 (1) This device may not cause harmful interference, and (2) this device must accept any interference received, including interference that may cause undesired operation.

This laser product complies with 21 CFR 1040 as applicable

CAUTION

LASER RADIATION - DO NOT STARE INTO BEAM

620-690nm
3.0 mW max. / <1.0 mW avg.
CLASS II LASER PRODUCT

LEICA GEOSYSTEMS AG
CH-9435 Heerbrugg Switzerland

Type: Manufactured:

Art. No.: S/N:

Power:

Made in



Laser Radiation

Do not stare into beam

Class 2 Laser Product

according to IEC 60825-1:2001

$P_0 \leq 3 \text{ mW}$
 $\lambda = 620 - 690 \text{ nm}$

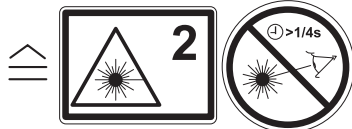

Electromagnetic Compatibility (EMC)

The term "electromagnetic compatibility" is taken to mean the capability of the laser unit to function smoothly in an environment where electromagnetic radiation and electrostatic discharges are present, and without causing electromagnetic disturbances to other equipment.



WARNING:

Electromagnetic radiation can cause disturbances in other equipment.

Although the laser units meet the strict regulations and standards which are in force in this respect, Leica Geosystems cannot completely exclude the possibility that other equipment may be disturbed.



CAUTION:

There is a risk that disturbances may be caused in other equipment if the laser unit is used in conjunction with accessories from other manufacturers, e.g. walkie-talkies, mobile phones.

Precautions: Use only the equipment and accessories recommended by Leica Geosystems. When combined with the laser unit, they meet the strict requirements stipulated by the guidelines and standards.



CAUTION:

Disturbances caused by electromagnetic radiation can result in the tolerance limits for measurements being exceeded.

Although the laser meets the strict regulations and standards which are in force in this connection, Leica Geosystems cannot completely exclude the possibility that the laser unit may be disturbed by very intense electromagnetic radiation, e.g. near radio transmitters, walkie-talkies, diesel generators, power cables.

Check the plausibility of results obtained under these conditions.

FCC Statement (applicable in the U.S.)



WARNING:

This equipment has been tested and found to comply with the limits for a Class B digital device, pursuant to part 15 of the FCC rules.

These limits are designed to provide reasonable protection against harmful interference in a residential installation.

This equipment generates, uses and can radiate frequency energy and, if not installed and used in accordance with the instructions, may cause harmful interference to radio communications. However, there is no guarantee that interference will not occur in a particular installation. If this equipment does cause harmful interference to radio or television reception, which can be determined by turning the equipment off and on, the user is encouraged to try to correct the interference by one or more of the following measures:

- Increase the separation between the equipment and the receiver.

- Consult the dealer or an experienced radio/TV technician for help.
- Reorient or relocate the receiving antenna.
- Connect the equipment into an outlet on a circuit different from that to which the receiver is connected.



WARNING:

Changes or modifications not expressly approved by Leica Geosystems could void the user's authority to operate the equipment.

This device complies with part 15 of the FCC Rules. Operation is subject to the following two conditions: (1) This device may not cause harmful interference, and (2) this device must accept any interference received, including interference that may cause undesired operation.

Leica Geosystems AG,
Heerbrugg, Switzerland,
has been certified as being
equipped with a quality
system which meets the
International Standards of
Quality Management and
Quality Systems (ISO stan-
dard 9001) and Environ-
mental Management
Systems (ISO standard
14001).



**Total Quality Management -
Our commitment to total
customer satisfaction.**

Ask your local Leica
Geosystems agent for more
information about our TQM
program.

- when it has to be **right**

Leica
Geosystems

727261-1.5.1en

Printed in Switzerland -
Copyright Leica Geosystems AG, Heerbrugg
Switzerland 2007
(Original Text)

Leica Geosystems AG
CH-9435 Heerbrugg
(Switzerland)
Phone +41 71 727 31 31
Fax +41 71 727 46 73
www.leica-geosystems.com